

LIQUID CRYSTAL DISPLAY MODULE

Product Specification

PRODUCT NUMBER	LMR5428
-----------------------	----------------

INTERNAL APPROVALS		
Product Manager	Engineering	Document Control
Date:	Date:	Date:

TABLE OF CONTENTS

1	PRODUCT SPECIFICATION	4
1.1	AVAILABLE FLUID AND POLARIZER TYPE	4
1.2	AVAILABLE BACKLIGHT TYPE AND COLOR.....	4
1.3	GENERAL SPECIFICATIONS.....	4
2	MECHANICAL DRAWINGS AND SCHEMATICS.....	5
2.1	FOR ALL COLORS EXCEPT SUNBURST YELLOW AND JADE GREEN BACKLIGHT.....	5
2.2	FOR JADE GREEN BACKLIGHT.....	6
2.3	FOR SUNBURST YELLOW BACKLIGHT	7
2.4	LCD WIRING DIAGRAM	8
2.5	PCB WIRING DIAGRAM.....	9
3	PIN CONNECTIONS	10
4	THE LED BACKLIGHT	10
4.1	MECHANICAL OUTLINE	10
4.2	ELECTRO-OPTICAL CHARACTERISTICS FOR BACKLIGHT	11
4.3	TEST POINT.....	12
4.4	CIRCUIT DIAGRAM.....	12
5	AC CHARACTERISTICS.....	13
6	ELECTRO-OPTICAL CHARACTERISTICS FOR LCD MODULE.....	14
7	RELIABILITY TEST.....	16
7.1	NORMAL TEMP.	16
7.2	WIDE TEMP.	16
8	THE LCD MEASURING METHOD AND EQUIPMENT	17
9	SAMPLE CODE.....	20
10	PART NUMBER DESCRIPTION FOR AVAILABLE OPTIONS	25
11	QUALITY ASSURANCE SPECIFICATION.....	26
11.1	CONFORMITY.....	26
11.2	DELIVERY ASSURANCE	26
12	HANDLING PRECAUTIONS.....	30

REVISION RECORD

Rev.	Date	Page	Par.	Comment	ECN no.
A	11/10/08	--	--	New DCA Specification	E3917
B	03/05/09	--	--	Added ASTN and ESTN Technologies	E4011
C	08/06/09	7	--	Corrected wiring diagram	E4153
D	09/14/09	--	--	Revision Documentation Update	E4182
E	12/02/09	7	--	LCD wiring diagram added	E4217
F	12/2/10	13	--	Added Min/Max values for Vdd logic.	E4388
G	07/08/11	4,6,11	--	Jade green module thickness changed to 8.10 ± 0.50 , typical luminance spec also updated	E4493
H	12/26/12	4,14,23	--	Transflective mode added	E4742
I	7/10/13	5~7, 20~24	--	Added epoxy glue to avoid separation between LCD and B/L. Sample code updated to include Read EEPROM procedure.	E4824
J	9/13/13	5~7, 11	--	Removed Epoxy Glue and added Black tape on top edge to avoid separation between LCD and B/L. Artic White B/L brightness range updated.	E4853

1 PRODUCT SPECIFICATION

1.1 AVAILABLE FLUID AND POLARIZER TYPE

LCD TYPE		STN		FSTN		ASTN (Automotive Grade)		ESTN (For Amber and Green Backlight only)	
		Normal Temp.	Wide Temp.	Normal Temp.	Wide Temp.	Normal Temp.	Wide Temp.	Normal Temp.	Wide Temp.
Transmissive	Negative	✓	✓	✓	✓	✓	✓	✓	✓
Transflective	Positive	X	X	X	✓	X	X	X	X

1.2 AVAILABLE BACKLIGHT TYPE AND COLOR

BACKLIGHT COLOR	Jade Green	Arctic White	Warm Amber	Midnight Blue	Tangerine Orange	Sunburst Yellow
Edge LED	✓	✓	✓	✓	✓	✓

1.3 GENERAL SPECIFICATIONS

ITEM	CONTENTS	UNIT
Outline Dimension	101.10 ± 0.20 (W) x 34.0 ± 0.20 (H) x 8.0 ± 0.50 (D) (*Note 1,2)(including mounting holes)	mm
Display Format	240 x 64	Dots
Viewing Area	82.0 (W) x 24.0 (H)	mm
Dot Size	0.29 x 0.29	mm
View Angle	12:00	O'clock
Duty Ratio	1/64	Duty
Bias	1/9	Bias
Module Operating Voltage	3.0	V
LCD Operating Voltage	12.0	V
LCD Driver	ST7529	-
RoHS Compliant	Yes	-

*Note 1: The Depth (D) dimension is 8.50 ± 0.50 (White LED + Yellow Filter) for Sunburst Yellow Backlight.

*Note 2: The Depth (D) dimension is 8.10 ± 0.50 for Jade Green Backlight.

Product No.	LMR5428	REV. J
-------------	---------	--------

Page	4 / 30
------	--------

2 MECHANICAL DRAWINGS AND SCHEMATICS

2.1 FOR ALL COLORS EXCEPT SUNBURST YELLOW AND JADE GREEN BACKLIGHT

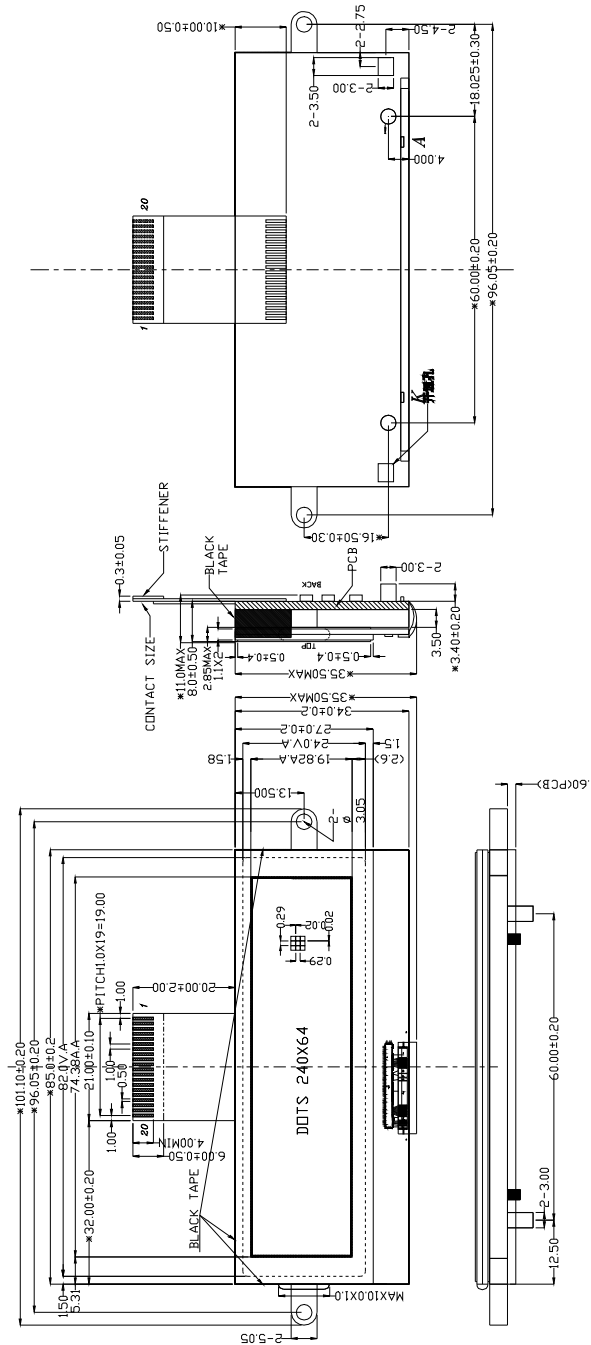

RECOMMENDED MATING CONNECTOR FOR LCM:
MOLEX 0522072051
MOLEX 0527932070
MOLEX 0522072060

Product No.	LMR5428	REV. J
-------------	---------	--------

Page	5 / 30
------	--------

2.2 FOR JADE GREEN BACKLIGHT

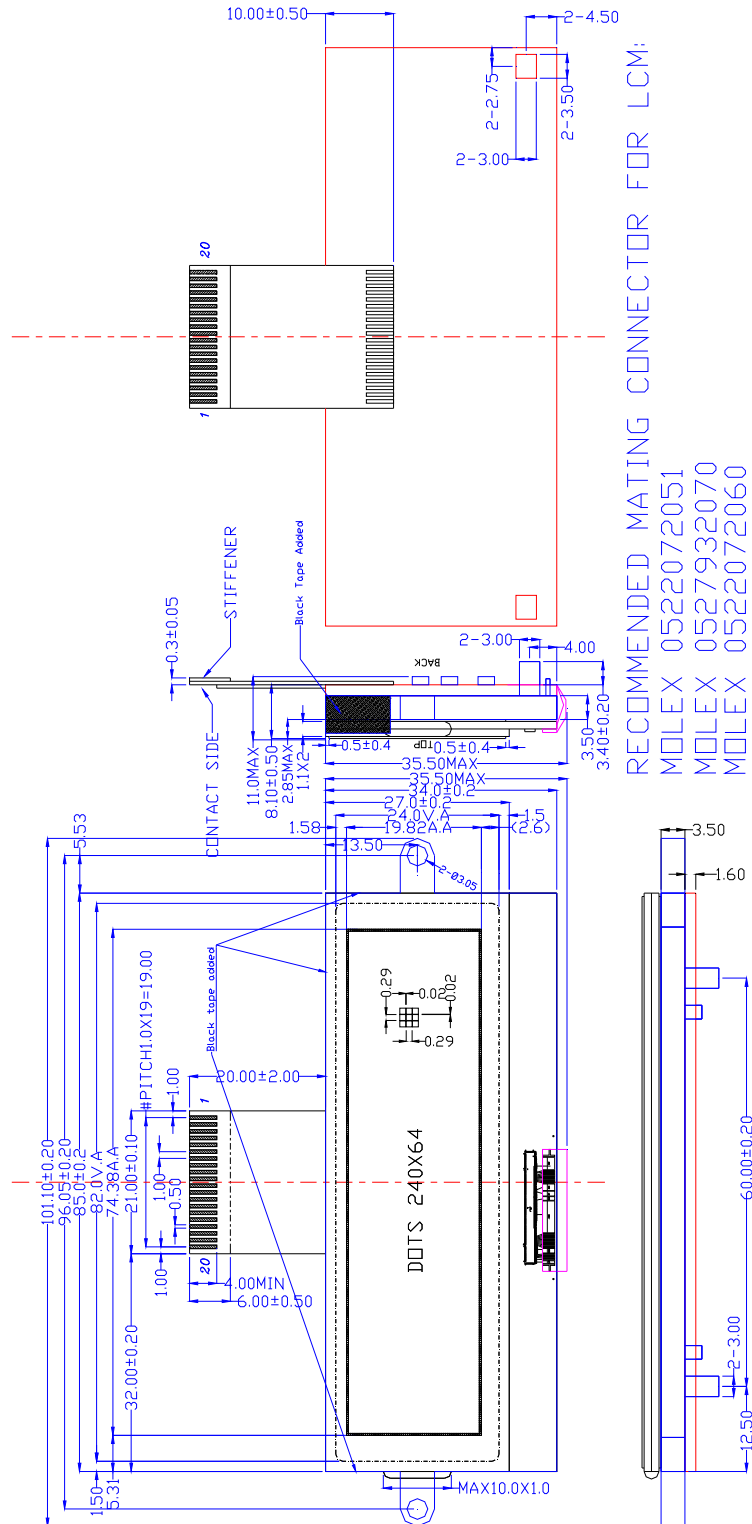

Product No.	LMR5428	REV. J
-------------	---------	--------

Page	6 / 30
------	--------

2.4 LCD WIRING DIAGRAM

Scan direction:

1.COM: COM0~COM63, COMMON SCAN (BBH)

2. SEG: SEG254~SEG15,, DATA SCAN DIRECTION(BCH)

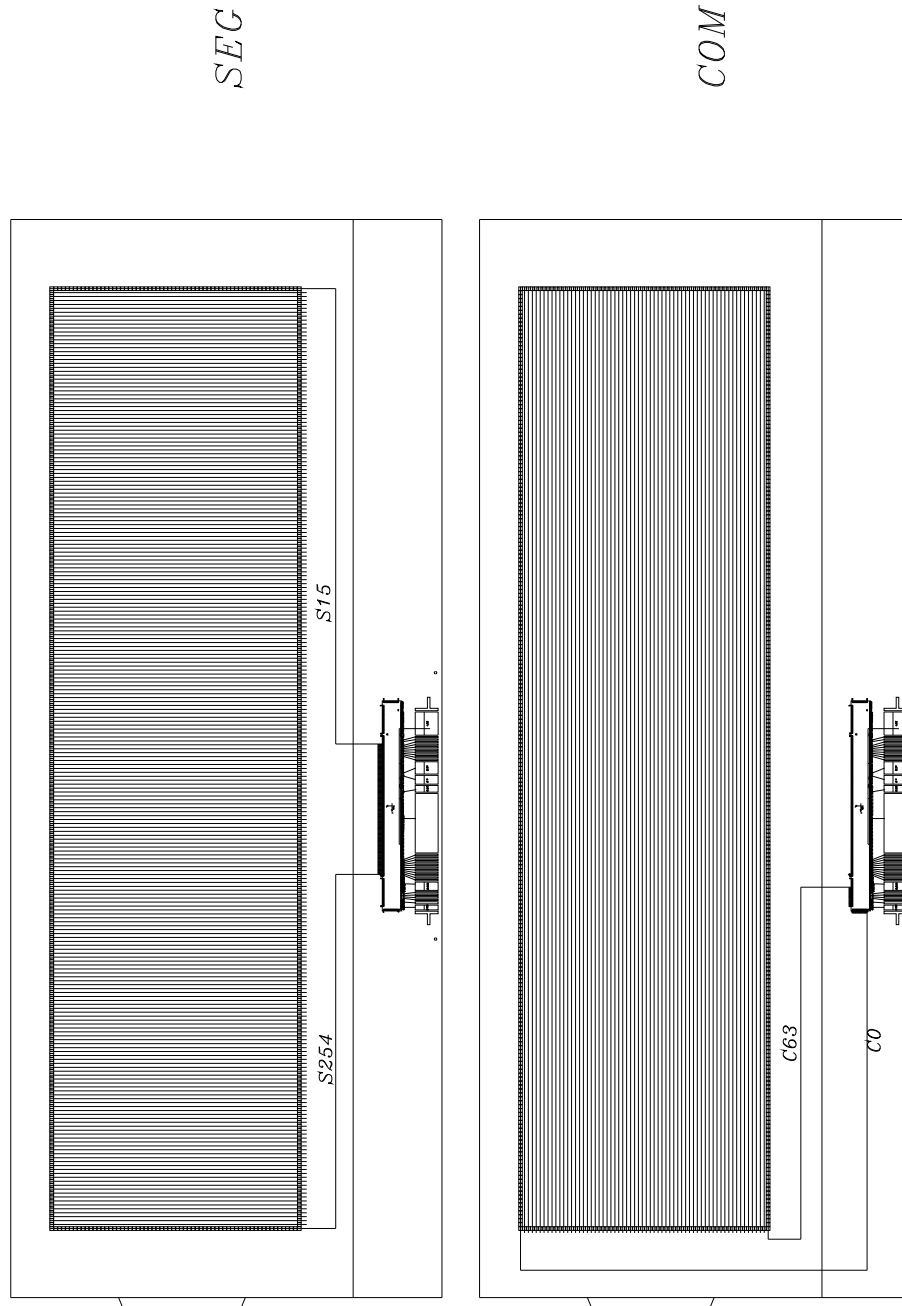

2.5 PCB WIRING DIAGRAM

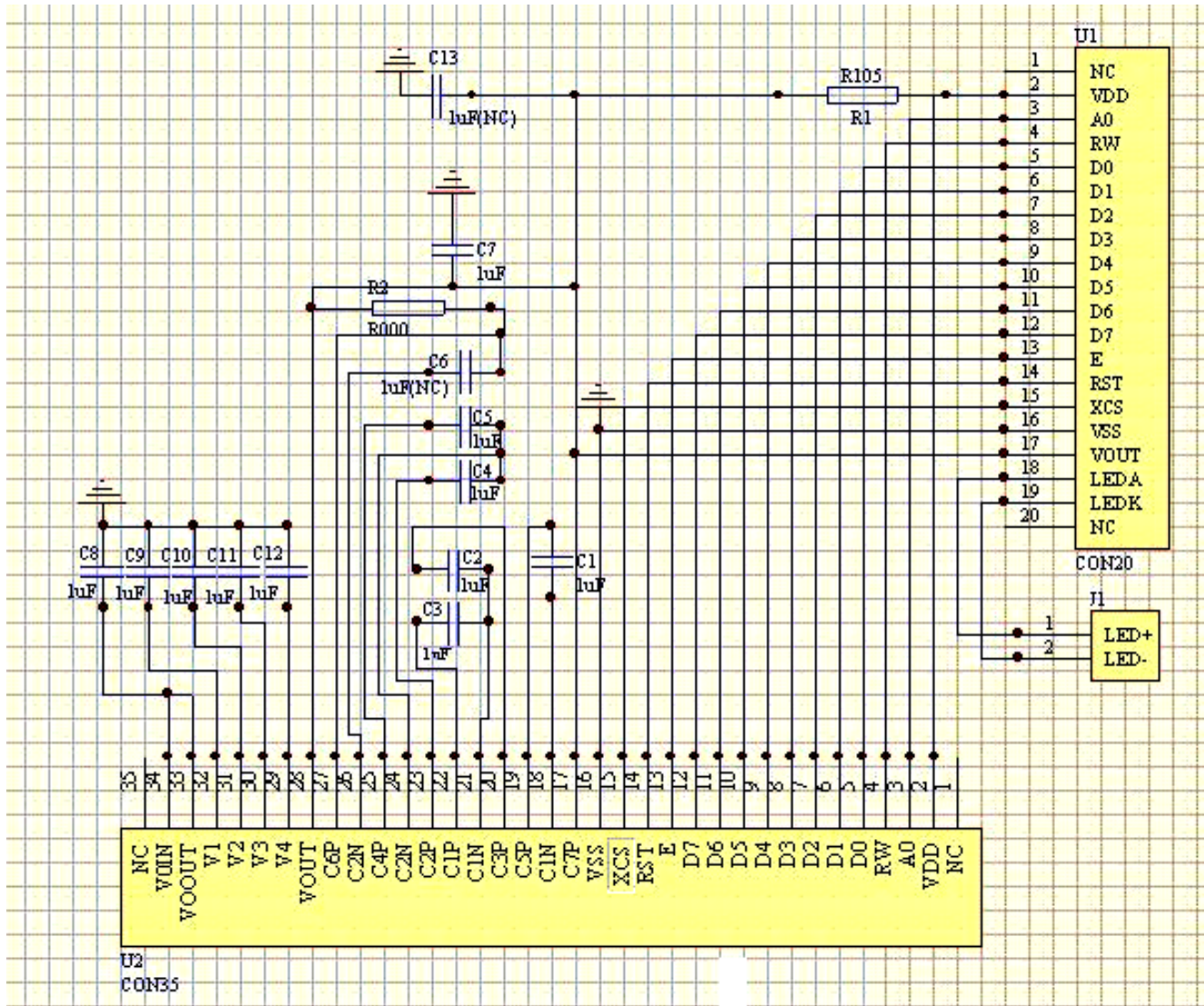

3 PIN CONNECTIONS

Pin No.	Symbol	Function
1	NC	No connection
2	VDD	Chip's power supply pin
3	A0	Register select input pin
4	RW	Read / write control input pin
5 ~ 12	D0 ~ D7	The 8-bit bi-directional data bus to be connected to the MCU in parallel interface mode
13	E	Read / write control input pin
14	RST	Reset input pin
15	XCS	Chip select input pin
16	VSS	Ground
17	VOUT	DC-DC voltage converter (No Connection)
18	LEDA	LED backlight power
19	LEDK	LED backlight power
20	NC	No connection

4 THE LED BACKLIGHT

4.1 MECHANICAL OUTLINE

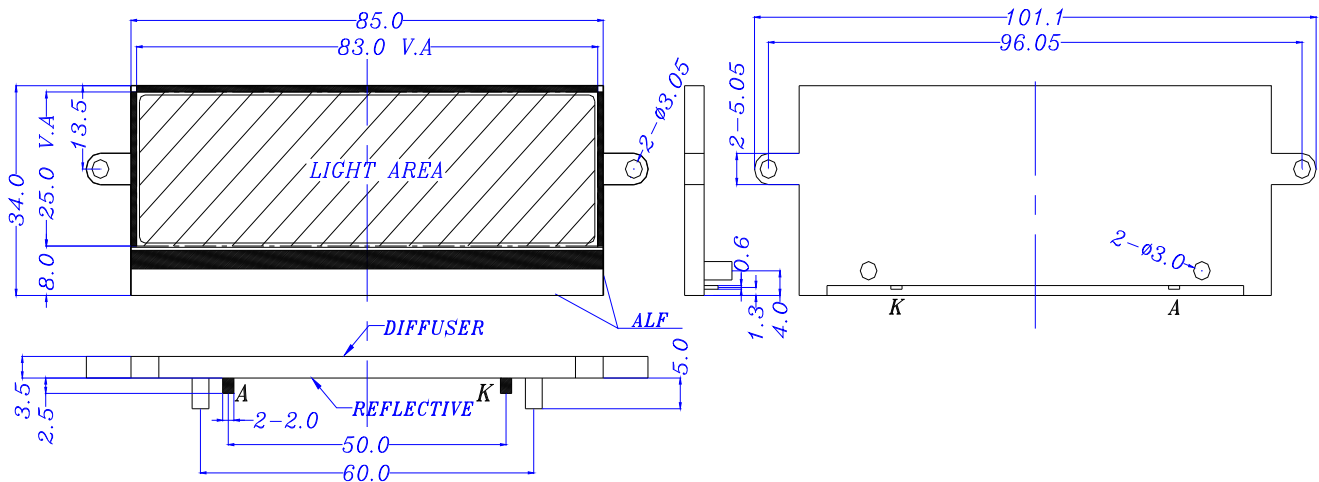

4.2 ELECTRO-OPTICAL CHARACTERISTICS FOR BACKLIGHT

Item	Color(s)	Symbol	Min.	Typ.	Max.	Unit	Condition
Forward Voltage	All	V _f	3.2	3.4	3.6	V	I _f = 90 mA (Note 1, 2 & 3)
Color Coordinate	Arctic White*	x	0.270	-	0.320	-	
		y	0.270	-	0.320	-	
Uniformity	All	Avg	70	-	-	%	
Luminance	Midnight Blue	L _v	60	-	-	cd/m ²	
	Warm Amber	L _v	120	-	-		
	Jade Green	L _v	40	60	90		
	Tangerine Orange	L _v	120	-	-		
	Sunburst Yellow	L _v	400	-	-		
	Arctic White*	L _v	530	750	960		
Dominant Wave length	Midnight Blue	λ _D	465	468	470	nm	
	Warm Amber	λ _D	584	589	594		
	Jade Green	λ _D	569	572	575		
	Tangerine Orange	λ _D	600	605	610		
Reverse Current (per LED)	Arctic White*, Sunburst Yellow & Midnight Blue	I _r	-	15	20	μA	V _r = 0.8 V
	Tangerine Orange, Warm Amber & Jade Green	I _r	-	-	15	μA	V _r = 3.0 V

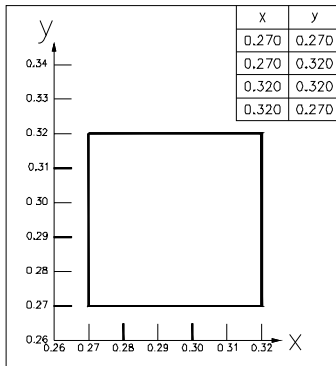

(*Coordinates for Arctic White Backlight)

Note 1: LED lifetime for Arctic White and Midnight Blue colour is Estimated to be 20000 hrs at 15mA / LED (25°C).

Note 2: LED lifetime for all other available colors is estimated to be 15000 hrs. at 15mA (25°C).

Note 3: Please refer to the PWM White Paper at http://www.densitron.com/displays/lcd_support.aspx for background on extending LED Backlight Lifetimes.

4.3 TEST POINT

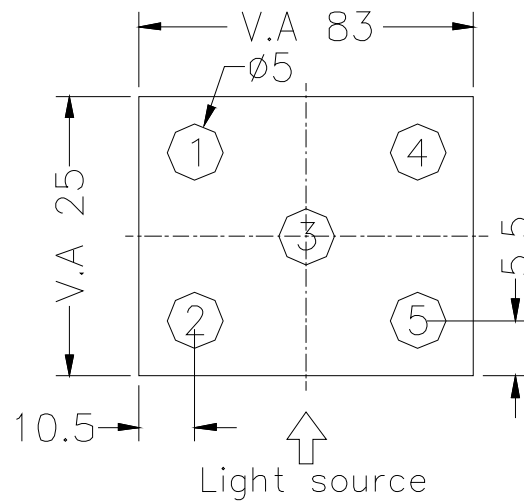

4.4 CIRCUIT DIAGRAM

LED 1 x 6 = 6 DIES, Colors: All

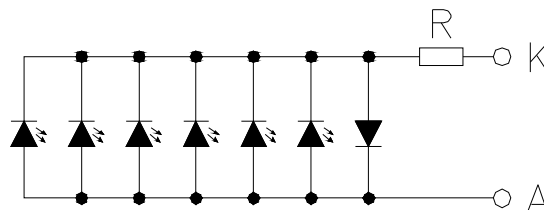

5 AC CHARACTERISTICS

System Bus Read/Write Characteristics 1 (For the 6800 Series MPU)

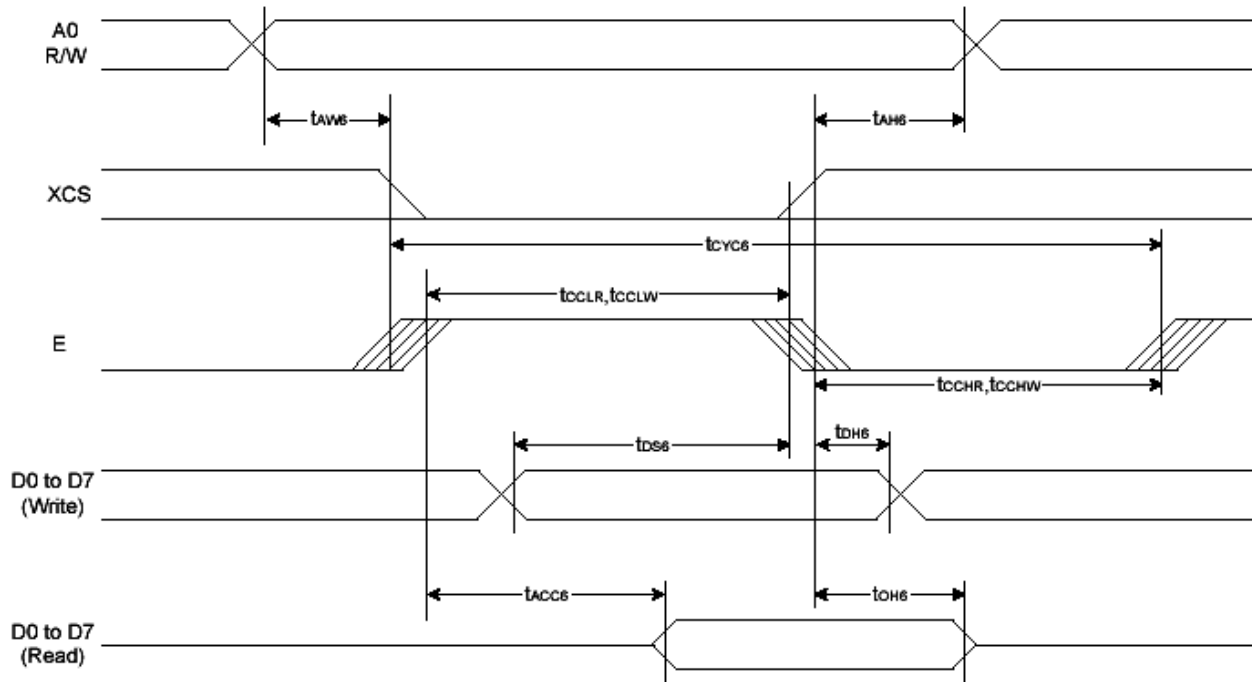

(VDD = 3.3 V , Ta = -30 to 85°C, Die)

Item	Signal	Symbol	Condition	Rating		Units
				Min.	Max.	
Address hold time	A0	tAH6	-	20	-	ns
Address setup time		tAW6	-	20	-	
System cycle time		tCYC6	-	200	-	
Enable L pulse width (WRITE)	WR	tEWLW	-	100	-	
Enable H pulse width (WRITE)		tEWHW	-	100	-	
Enable L pulse width (READ)	RD	tEWLR	-	100	-	
Enable H pulse width (READ)		tEWHR	-	100	-	
WRITE Data setup time	D0 to D7	tDS6	-	150	-	
WRITE Data hold time		tDH6	-	20	-	
READ access time		tACC6	CL = 100 pF	-	40	
READ Output disable time		tOH6	CL = 100 pF	-	30	

6 ELECTRO-OPTICAL CHARACTERISTICS FOR LCD MODULE

(Temp. = 23 ± 3 °C)

Item		Symbol	Condition	Min	Typ.	Max	Unit	
Supply Voltage (Logic)		$V_{DD} - V_{SS}$	-	2.4	3.0	3.3	V	
Power Requirements		I_{dd}	-	0.63	-	1.73	mA	
LCD Operating Voltage		$V_{DD} - V_O$	Normal Temp.	-10°C	-	12.3	-	V
				25°C	-	12.0	-	
			Wide Temp.	50°C	-	11.8	-	
				-20°C	-	12.4	-	
				25°C	-	12.0	-	
				80°C	-	11.6	-	
Response Time	STN	T_{on}	-	-	72	-	ms	
		T_{off}	-	-	224	-		
	FSTN	T_{on}	-	-	64	-		
		T_{off}	-	-	276	-		
	ASTN	T_{on}	-	-	108	-		
		T_{off}	-	-	200	-		
	ESTN	T_{on}	-	-	32	-		
		T_{off}	-	-	388	-		
Contrast		CR	-	2	-	10.9	-	
Viewing Angle	STN	12H	$\Theta 1$	CR ≥ 2.0	-	58	-	Deg.
		6H	$\Theta 2$		-	55	-	
		3H	$\Theta 3$		-	53	-	
		9H	$\Theta 4$		-	53	-	
	FSTN(Negative Mode)	12H	$\Theta 1$		-	58	-	
		6H	$\Theta 2$		-	56	-	
		3H	$\Theta 3$		-	53	-	
		9H	$\Theta 4$		-	53	-	
	FSTN(Positive Mode)	12H	$\Theta 1$		-	55	-	
		6H	$\Theta 2$		-	68	-	
		3H	$\Theta 3$		-	50	-	
		9H	$\Theta 4$		-	50	-	
	ASTN	12H	$\Theta 1$		-	60	-	
		6H	$\Theta 2$		-	40	-	
		3H	$\Theta 3$		-	50	-	
		9H	$\Theta 4$		-	50	-	
	ESTN	12H	$\Theta 1$		-	40	-	
		6H	$\Theta 2$		-	60	-	
		3H	$\Theta 3$		-	60	-	
		9H	$\Theta 4$		-	54	-	
LCD Threshold Voltage		V_{th}	25°C	-	10.1	-	V	

POWER REQUIREMENTS

Item	Symbol	Min.	Typ.	Max.	Unit
Module	I _{dd}	0.63	-	1.73	mA
LED	PD	-	306	-	mW

7 RELIABILITY TEST

7.1 NORMAL TEMP.

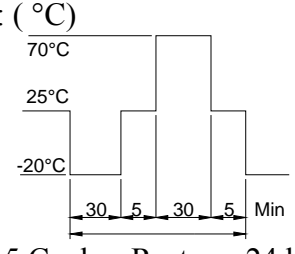
No.	Items	Test Condition	Equipment	Test Result
1	High Temp. Storage	Temp.: 70 ± 2 °C, Time: 96 h Restore: 24 h	Tenny	Passed
2	Low Temp. Storage	Temp.: -20 ± 3 °C, Time: 96 h Restore: 24 h	Tenny	Passed
3	High Temp. Operating	Temp.: 50 ± 2 °C, Time: 24 h Restore: 24 h	Tenny	Passed
4	Low Temp. Operating	Temp.: -10 ± 2 °C, Time: 24 h Restore: 24 h	Tenny	Passed
5	High Temp. / High Humidity Storage	Temp.: 40 ± 2 °C, Hum: 95% RH Time: 96 h, Restore: 24 h	Tenny	Passed
6	Thermal Shock	Temp.: (°C)  5 Cycles, Restore: 24 h	Tenny	Passed

7.2 WIDE TEMP.

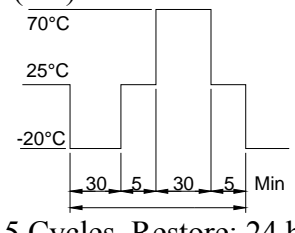
No.	Items	Test Condition	Equipment	Test Result
1	High Temp. Storage	Temp.: 80 ± 2 °C, Time: 96 h Restore: 24 h	Tenny	Passed
2	Low Temp. Storage	Temp.: -30 ± 3 °C, Time: 96 h Restore: 24 h	Tenny	Passed
3	High Temp. Operating	Temp.: 70 ± 2 °C, Time: 24 h Restore: 24 h	Tenny	Passed
4	Low Temp. Operating	Temp.: -20 ± 2 °C, Time: 24 h Restore: 24 h	Tenny	Passed
5	High Temp. / High Humidity Storage	Temp.: 40 ± 2 °C, Hum: 95% RH Time: 96 h, Restore: 24 h	Tenny	Passed
6	Thermal Shock	Temp.: (°C)  5 Cycles, Restore: 24 h	Tenny	Passed

8 THE LCD MEASURING METHOD AND EQUIPMENT

1. Threshold Voltage and Response Time Measuring.

(1) Equipment:

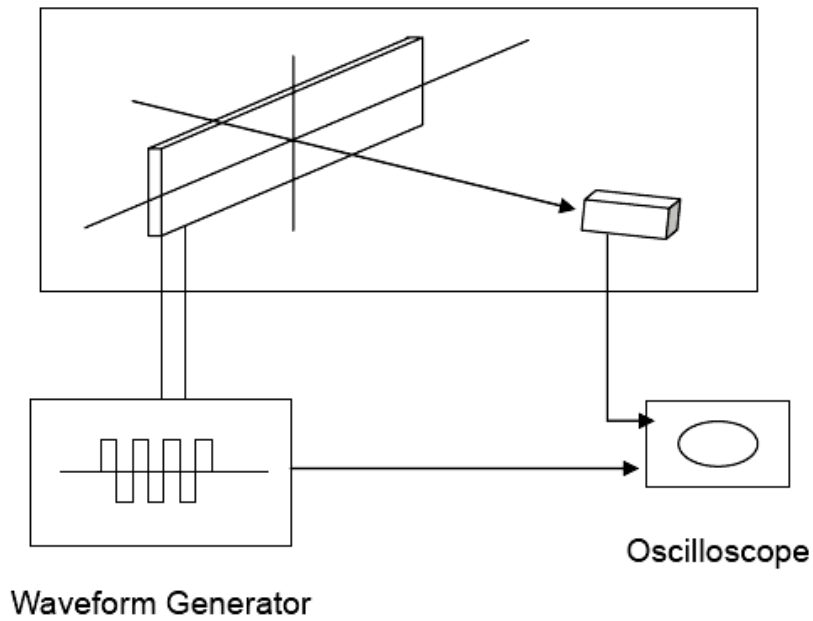

(2) Definition:

A. Threshold Voltage: (V_{th})

Brightness

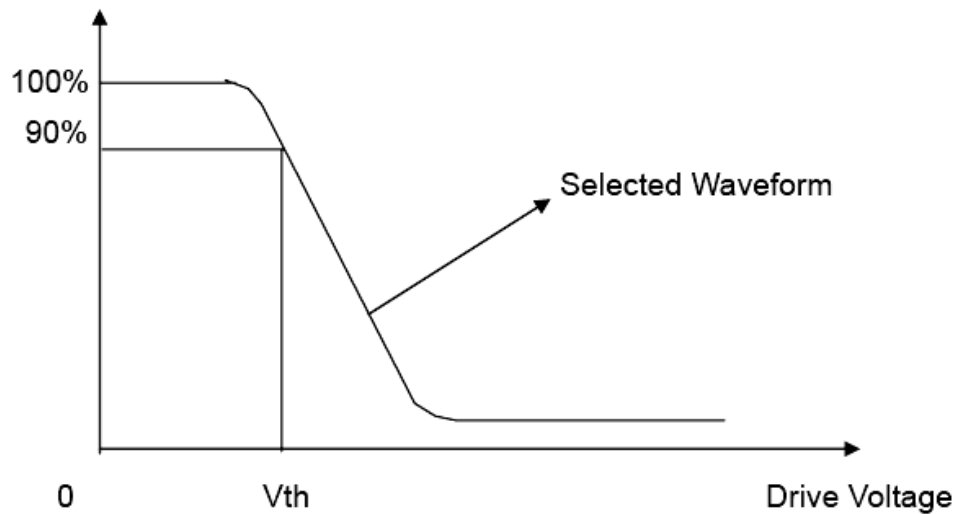

B. Response Time:

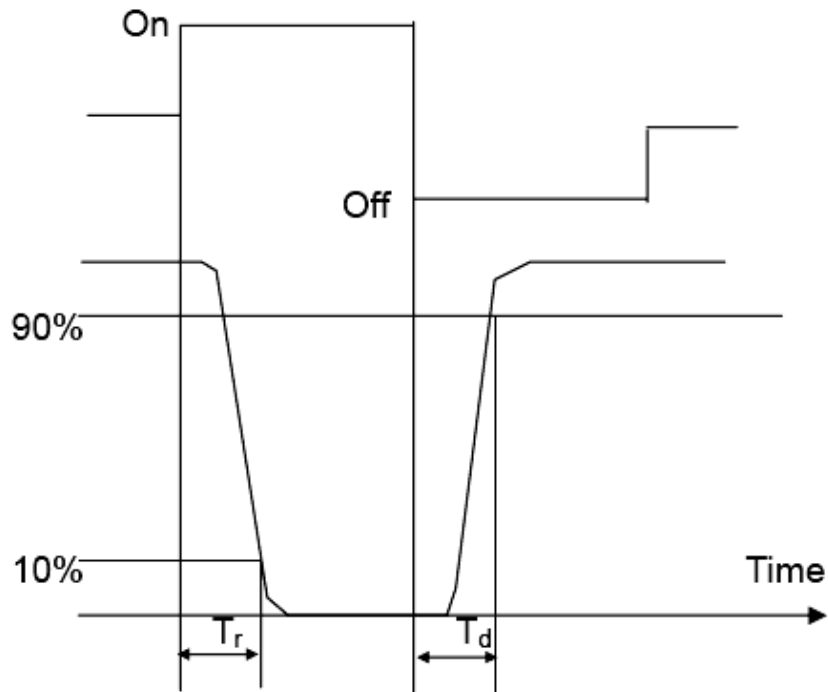

2. Contrast Measuring.

(1) Equipment:

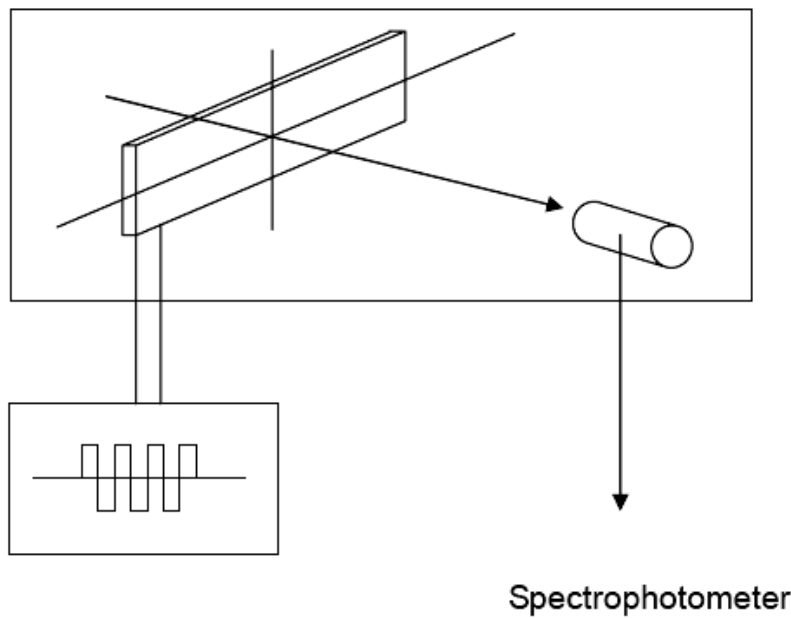

Waveform Generator

Spectrophotometer

(2) Definition:

A. Viewing Angle:

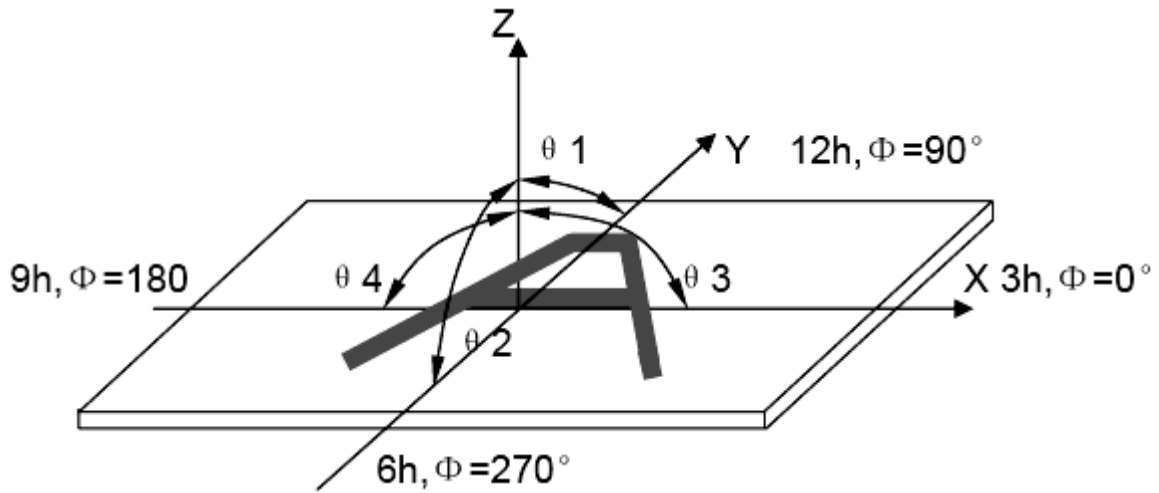

B. Contrast Ratio: (Positive)

$$CR = \frac{\text{Brightness of non-selected wave-form}}{\text{Brightness of selected wave-form}}$$

9 SAMPLE CODE

```

#include <reg52.h>
#include <intrins.h>
#include "delay.h"
// #include "isp.h"

sbit  rs    =    P2^0;
sbit  rw    =    P2^1;
sbit  e     =    P2^2;
sbit  res   =    P2^3;
sbit  cs    =    P2^4;
sfr   db    =    0x90;

#include "6800.h"
#include "image.h"
#include "lcd_test.h"

void main()
{
    unsigned char i,j;

    delay_us(0);
    delay_ms(0);
    delay_ss(0);
//    isp_init();

    while(1)
    {
        res=0;
        delay_ss(1);
        res=1;

        cs=0;

        while(1)
        {
            write_com(0x30);    // ext=0
            write_com(0x94);    // sleep out
            write_com(0xd1);    // osc on
            write_com(0x20);    // power control set
            write_dat(0x08);    // booster must be on first
            delay_ms(2);
            write_com(0x20);    // power control set

```

Product No.	LMR5428	REV. J
-------------	---------	--------

Page	20 / 30
------	---------

```

write_dat(0x0b); // booster,regulator follower on
write_com(0x81); // electronic control
write_dat(18); // set vop low: 00~3f vlcd=12.0v
write_dat(0x03); // hige:00~07
0x28,0x03=13.0
write_com(0xca); // display control
write_dat(0x04); //

write_dat(15); // 1f duty=1/64
write_dat(0x00); // ;10GOOD;

write_com(0xa6); // normal display

write_com(0xbb); // com scan direction
write_dat(0x00); // 0~79,159~80 64COM:0~63

write_com(0xbc); // data scan direction
write_dat(0x02); //
write_dat(0x01); //
write_dat(0x02); //

write_com(0x75); // line address set
write_dat(0); // start line =0
write_dat(63); // end line =127

write_com(0x15); // column address set
write_dat(0); // start column =0
write_dat(79); // end column =79

write_com(0x31); // ext=1
write_com(0x20); // set gray level
for(i=0;i<16;i++)
{
    write_dat(1);
}

write_com(0x21);
for(i=0;i<16;i++)
{
    write_dat(1);
}

write_com(0x32); // analog circuit set

```

```

****      write_dat(0x01);      // osc frequency=000 (default)

      write_dat(0x00);      // booster efficiency=01 (default)
      write_dat(0x05);      // bias=1/9      ****
      write_com(0x34);      // dithering off
ReadEEPROM();      // read eeprom flow
      write_com(0xaf);      // display on

      write_com(0x5c);      // write data
      lcd_full();
delay_ms(200);
      lcd_line1();
      delay_ms(200);
      lcd_line2();
      delay_ms(200);
      lcd_line3();
      delay_ms(200);
      lcd_line4();
      delay_ms(200);

      lcd_erec1();
      delay_ms(200);
      lcd_erec2();
      delay_ms(200);
      lcd_erec3();
      delay_ms(200);
      lcd_erec4();
      delay_ms(200);

      /*
      write_com(0x5c);      // write data
      lcd_image(image_yes);
      delay_ss(1);
      */

      lcd_image(image_yes1);
      delay_ss(1);

      }
}
}

```

Note: Please make sure to include EEPROM Read operation into the code, this is essential for the display contrast settings to perform at optimal conditions.

```
void ReadEEPROM( void )
{
    Write( COMMAND, 0x0030 );           // Ext = 0
    Write( COMMAND, 0x0007 );           // Initial code (1)
    Write( DATA, 0x0019 );
    Write( COMMAND, 0x0031 );           // Ext = 1
    Write( COMMAND, 0x00CD );           // EEPROM ON
    Write( DATA, 0x0000 );             // Entry "Read Mode"
    Delay( 100ms );                     // Waite for EEPROM Operation ( 100ms )
    Write( COMMAND, 0x00FD );           // Start EEPROM Reading Operation
    Delay( 100ms );                     // Waite for EEPROM Operation ( 100ms )
    Write( COMMAND, 0x00CC );           // Exist EEPORM Mode
    Write( COMMAND, 0x0030 );           // Ext = 0
}
}
```

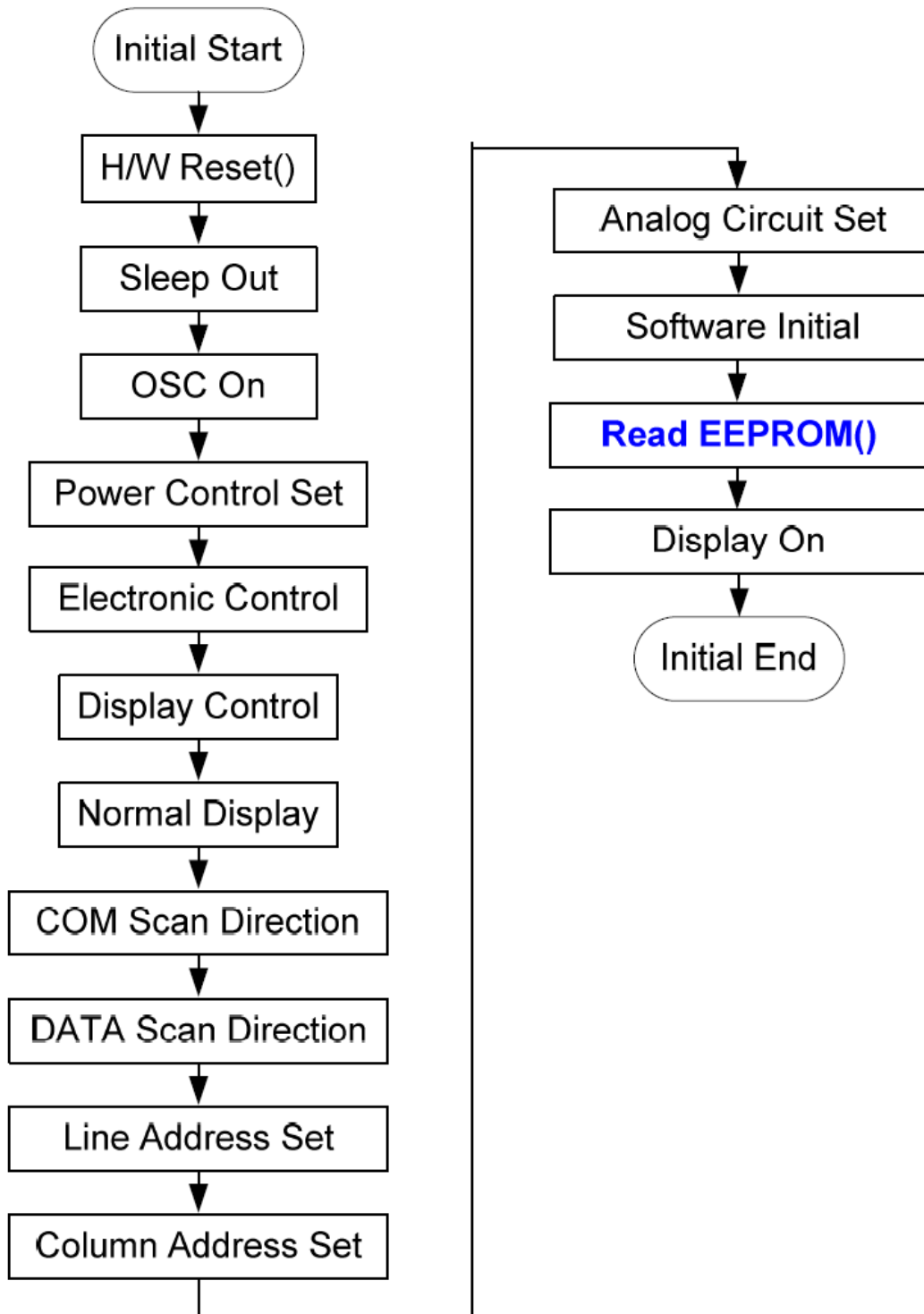

10 PART NUMBER DESCRIPTION FOR AVAILABLE OPTIONS

LMR5428①②240G64③④⑤

①

Polarizer Type

E = Transmissive Negative Mode

B = Transflective Positive Mode

②

Backlight Color

A = Warm Amber

G = Jade Green

B = Midnight Blue

W = Arctic White

O = Tangerine Orange

Y = Sunburst Yellow

③

Fluid Type and Temperature Range

S = Standard temp. range

W = Wide temp. range

④

Fluid Type and Temperature Compensation

N = STN

F = FSTN

A = ASTN (Automotive grade)

E = ESTN (For Amber and Green Backlight only)

⑤

Background Color

B = Blue mode STN (Ocean Blue)

11 QUALITY ASSURANCE SPECIFICATION

11.1 CONFORMITY

The performance, function and reliability of the shipped products conform to the Product Specification.

11.2 DELIVERY ASSURANCE

11.2.1 Delivery Inspection Standards

- IPC-AA610, Class 2 Electronic assemblies' standard.

The Quality assurance levels are shown below:

Rank	Item Inspected	Defect type	AQL	Remark		
Major defect	Display	No display	0.25%	Fit/Function defect		
		Over current				
		Missing segment				
		Wrong Viewing direction				
		Incorrect operation				
		No Backlight				
	Flickering Backlight					
	Dimensions	PCB and/or Bezel out of Specifications				
Minor defect	LCD	Black and White spots	1.0%	Appearance defect		
		Black and White lines				
		Polarizer Scratches				
		Bubbles in Polarizer				
		Segment deformations, Pin holes				
		Color Defect				
	COB	Glass Chips				
		Wire Bonding Pad exposed				
		Insufficient covering with Resin (Wire Bonding line exposed)				
	PCB	Bubbles or Dust on COB				
		Dust or Solder balls on PCB				
		Tray			Pad Scratches	
		Particles		Every Tray		
		Total	1.0%			

11.2.2 Zone Definition

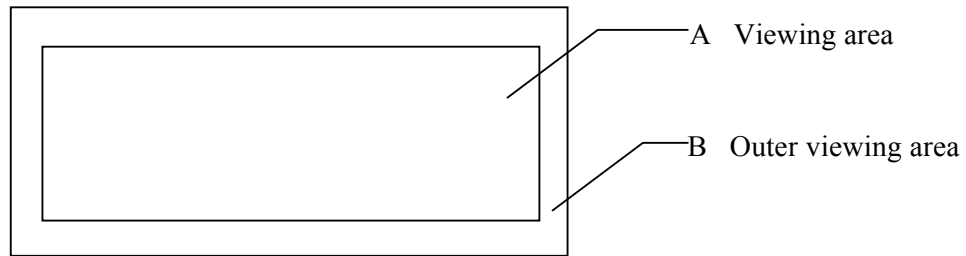

11.2.3 Visual Inspection

- ❖ Inspect under 2 x 20 W or one 40 W fluorescent lamp (approximately 3000 lux.) leaving 25 to 30 cm between the module and the lamp and 30 cm between the module and the eye. (Measuring position).
- ❖ Appearance is inspected at the best contrast voltage (best contrast is adjusted by considering clarity and crosstalk on the screen).
- ❖ Inspect the module at 45° right and left, top and bottom.
- ❖ Use the optimum viewing angle during the contrast inspection.

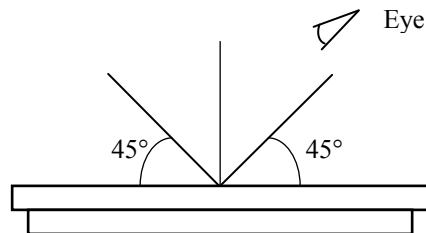

11.2.3.1 Standard of Appearance Inspection

Unit: mm

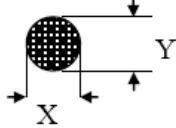
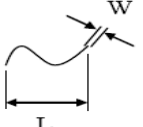
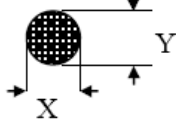
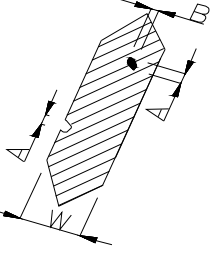
No.	Item	Criteria																															
1	Black spot, White spot, Dust	<p>Round type as shown: $\Phi = (X+Y)/2$</p>  <table border="1" data-bbox="789 441 1279 604"> <thead> <tr> <th colspan="3">Acceptable quantity</th> </tr> <tr> <th>Size</th> <th>Zone A</th> <th>Zone B</th> </tr> </thead> <tbody> <tr> <td>$\Phi < 0.2$</td> <td>Any number</td> <td rowspan="3">Any number</td> </tr> <tr> <td>$0.2 < \Phi < 0.25$</td> <td>2</td> </tr> <tr> <td>$0.25 < \Phi$</td> <td>0</td> </tr> </tbody> </table> <p>Line type as shown:</p>  <table border="1" data-bbox="669 646 1351 810"> <thead> <tr> <th colspan="4">Acceptable quantity</th> </tr> <tr> <th>Length</th> <th>Width</th> <th>Zone A</th> <th>Zone B</th> </tr> </thead> <tbody> <tr> <td>-</td> <td>$W \leq 0.03$</td> <td>Any number</td> <td rowspan="3">Any number</td> </tr> <tr> <td>$L \leq 3$</td> <td>$0.03 < W \leq 0.05$</td> <td>2</td> </tr> <tr> <td>-</td> <td>$0.05 < W$</td> <td>As round type</td> </tr> </tbody> </table> <p>Total acceptable quantity: 5</p>	Acceptable quantity			Size	Zone A	Zone B	$\Phi < 0.2$	Any number	Any number	$0.2 < \Phi < 0.25$	2	$0.25 < \Phi$	0	Acceptable quantity				Length	Width	Zone A	Zone B	-	$W \leq 0.03$	Any number	Any number	$L \leq 3$	$0.03 < W \leq 0.05$	2	-	$0.05 < W$	As round type
Acceptable quantity																																	
Size	Zone A	Zone B																															
$\Phi < 0.2$	Any number	Any number																															
$0.2 < \Phi < 0.25$	2																																
$0.25 < \Phi$	0																																
Acceptable quantity																																	
Length	Width	Zone A	Zone B																														
-	$W \leq 0.03$	Any number	Any number																														
$L \leq 3$	$0.03 < W \leq 0.05$	2																															
-	$0.05 < W$	As round type																															
2	Polarizer Scratch	Scratch on Protective film is permitted. Scratch on Polarizer: Same as 1.																															
3	Polarizer Bubble	<p>$\Phi = (X+Y)/2$</p>  <table border="1" data-bbox="812 1039 1279 1234"> <thead> <tr> <th colspan="3">Acceptable quantity</th> </tr> <tr> <th>Size</th> <th>Zone A</th> <th>Zone B</th> </tr> </thead> <tbody> <tr> <td>$\Phi < 0.2$</td> <td>Any number</td> <td rowspan="4">Any number</td> </tr> <tr> <td>$0.2 < \Phi < 0.5$</td> <td>3</td> </tr> <tr> <td>$0.5 < \Phi < 1.0$</td> <td>1</td> </tr> <tr> <td>$1.0 < \Phi$</td> <td>0</td> </tr> </tbody> </table> <p>Total acceptable quantity: 4</p>	Acceptable quantity			Size	Zone A	Zone B	$\Phi < 0.2$	Any number	Any number	$0.2 < \Phi < 0.5$	3	$0.5 < \Phi < 1.0$	1	$1.0 < \Phi$	0																
Acceptable quantity																																	
Size	Zone A	Zone B																															
$\Phi < 0.2$	Any number	Any number																															
$0.2 < \Phi < 0.5$	3																																
$0.5 < \Phi < 1.0$	1																																
$1.0 < \Phi$	0																																
4	Segment Deformation	<p>I.a. Pin hole on segmented display:</p> <p>W: Segment Width</p> <p>$\Phi = (A+B)/2$</p>  <table border="1" data-bbox="738 1491 1299 1738"> <thead> <tr> <th colspan="2">Acceptable quantity</th> </tr> <tr> <th>Width</th> <th>Φ</th> </tr> </thead> <tbody> <tr> <td>$W \leq 0.4$</td> <td>$\Phi \leq 0.2$ and $\Phi \leq \frac{1}{2}W$</td> </tr> <tr> <td>$W > 0.4$</td> <td>$\Phi \leq 0.25$ and $\Phi \leq (1/3)W$</td> </tr> </tbody> </table> <p>Total acceptable quantity: 1 Defect per segment. Pin holes with Φ under 0.10 mm are acceptable.</p>	Acceptable quantity		Width	Φ	$W \leq 0.4$	$\Phi \leq 0.2$ and $\Phi \leq \frac{1}{2}W$	$W > 0.4$	$\Phi \leq 0.25$ and $\Phi \leq (1/3)W$																							
Acceptable quantity																																	
Width	Φ																																
$W \leq 0.4$	$\Phi \leq 0.2$ and $\Phi \leq \frac{1}{2}W$																																
$W > 0.4$	$\Phi \leq 0.25$ and $\Phi \leq (1/3)W$																																

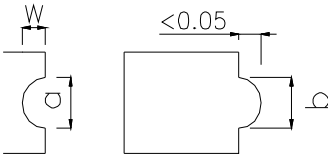
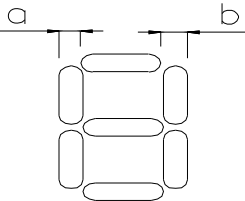
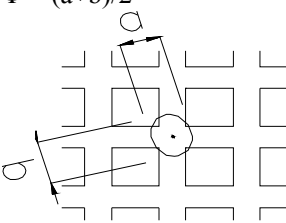
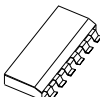
No.	Item	Criteria																												
4	Segment Deformation	<p>1.b. Pin hole on dot matrix display:</p>  <table border="1" data-bbox="876 325 1307 493"> <thead> <tr> <th colspan="2">Acceptable quantity</th> </tr> </thead> <tbody> <tr> <td>Size</td> <td>-</td> </tr> <tr> <td>$a, b < 0.1$</td> <td>Any number</td> </tr> <tr> <td>$(a+b)/2 \leq 0.1$</td> <td>Any number</td> </tr> <tr> <td>$0.5 < \Phi < 1.0$</td> <td>3</td> </tr> </tbody> </table> <p>Total acceptable quantity: 7</p> <p>2. Segments / dots with different width:</p>  <table border="1" data-bbox="876 703 1307 808"> <thead> <tr> <th colspan="2">Acceptable limits</th> </tr> </thead> <tbody> <tr> <td>$a \geq b$</td> <td>$a/b \leq 4/3$</td> </tr> <tr> <td>$a < b$</td> <td>$a/b > 4/3$</td> </tr> </tbody> </table> <p>3. Alignment layer defect:</p> <p>$\Phi = (a+b)/2$</p>  <table border="1" data-bbox="876 955 1307 1155"> <thead> <tr> <th colspan="2">Acceptable quantity</th> </tr> </thead> <tbody> <tr> <td>Size</td> <td>-</td> </tr> <tr> <td>$\Phi \leq 0.4$</td> <td>Any number</td> </tr> <tr> <td>$0.4 < \Phi \leq 1.0$</td> <td>5</td> </tr> <tr> <td>$1.0 < \Phi \leq 1.5$</td> <td>3</td> </tr> <tr> <td>$1.5 < \Phi \leq 2.0$</td> <td>2</td> </tr> </tbody> </table>	Acceptable quantity		Size	-	$a, b < 0.1$	Any number	$(a+b)/2 \leq 0.1$	Any number	$0.5 < \Phi < 1.0$	3	Acceptable limits		$a \geq b$	$a/b \leq 4/3$	$a < b$	$a/b > 4/3$	Acceptable quantity		Size	-	$\Phi \leq 0.4$	Any number	$0.4 < \Phi \leq 1.0$	5	$1.0 < \Phi \leq 1.5$	3	$1.5 < \Phi \leq 2.0$	2
Acceptable quantity																														
Size	-																													
$a, b < 0.1$	Any number																													
$(a+b)/2 \leq 0.1$	Any number																													
$0.5 < \Phi < 1.0$	3																													
Acceptable limits																														
$a \geq b$	$a/b \leq 4/3$																													
$a < b$	$a/b > 4/3$																													
Acceptable quantity																														
Size	-																													
$\Phi \leq 0.4$	Any number																													
$0.4 < \Phi \leq 1.0$	5																													
$1.0 < \Phi \leq 1.5$	3																													
$1.5 < \Phi \leq 2.0$	2																													
5	Color Uniformity	Level of samples for approval is set as the limit.																												
6	Backlight	The backlight color should correspond to the product specification. Flashing / flickering and / or non-functioning backlight is not allowed. Dust larger than 0.25 mm is not allowed.																												
7	COB	Exposed wire bonding pad is not allowed. Insufficient covering with resin is not allowed. (Exposed Wire bonding line) Dust or bubbles on the resin are not allowed.																												
8	 PCB	Non-melted solder paste should not be present on the PCB. Cold solder joints, missing solder connections, or oxidation is not allowed. Residue or solder balls on the PCB are not allowed. Short circuits on components are not allowed.																												

12 HANDLING PRECAUTIONS

Safety

If the LCD panel breaks, be careful not to get the liquid crystal fluid in your mouth or in your eyes.
If the liquid crystal touches your skin or clothes, wash it off immediately using soap and plenty of water.

Mounting and Design

Place a transparent plate (e.g. acrylic, polycarbonate or glass) on the display surface to protect the display from external pressure. Leave a small gap between the transparent plate and the display surface.
When assembling with a zebra connector, clean the surface of the pads with alcohol and keep the surrounding air very clean. Design the system so that no input signal is given unless the power supply voltage is applied.

Caution during LCD cleaning

Lightly wipe the display surface with a soft cloth soaked with Isopropyl alcohol, Ethyl alcohol or Trichlorotrifluoroethane. Do not wipe the display surface with dry or hard materials that will damage the polarizer surface. Do not use aromatic solvents (toluene and xylene), or ketonic solvents (ketone and acetone).

Caution against static charge

As the display uses C-MOS LSI drivers, connect any unused input terminals to VDD or VSS. Do not input any signals before power is turned on. Also, ground your body, work / assembly table and assembly equipment to protect against static electricity.

Packaging

Displays use LCD elements, and must be treated as such. Avoid strong shock and drop from a height.
To prevent displays from degradation, do not operate or store them exposed directly to sunlight or high temperature / humidity.

Caution during operation

It is indispensable to drive the display within the specified voltage limit since excessive voltage shortens its life. Direct current causes an electrochemical reaction with remarkable deterioration of the display quality. Give careful consideration to prevent direct current during ON/OFF timing and during operation.
Response time is extremely delayed at temperatures lower than the operating temperature range while, at high temperatures, displays become dark. However, this phenomenon is reversible and does not mean a malfunction or a display that has been permanently damaged. If the display area is pushed on hard during operation, some graphics will be abnormally displayed but returns to a normal condition after turning off the display once. Even a small amount of condensation on the contact pads (terminals) can cause an electrochemical reaction which causes missing rows and columns. Give careful attention to avoid condensation.

Storage

Store the display in a dark place where the temperature is 25°C ± 10°C and the humidity below 50% RH.
Store the display in a clean environment, free from dust, organic solvents and corrosive gases.
Do not crash, shake or jolt the display (including accessories).

Product No.	LMR5428	REV. J
-------------	---------	--------

Page	30 / 30
------	---------